



EXCELÊNCIA EM CADA AMBIENTE





P I C I  
0 9 F 3

PICI  
09F3



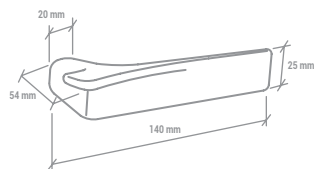

# PICI

09F3

Zamac



CONJUNTOS	CANTO	FECHADURA 4000 EXTERNA	FECHADURA 1700 EXTERNA (1750) CILINDRO 70MM	FECHADURA 1700 INTERNA (1851)	FECHADURA 1700 BANHEIRO (1952)
PICI 09F3 Guarnições 096 PP	RETO	CJF396E40PP00	CJF396E17PP002	CJF396I18PP00	CJF396B19PP00
	RED	CJF396E40PP00R	CJF396E17PP003	CJF396I18PP00R	CJF396B19PP00R
PICI 09F3 Guarnições 096 CR	RETO	CJF396E40CR00	CJF396E17CR002	CJF396I18CR00	CJF396B19CR00
	RED	CJF396E40CR00R	CJF396E17CR003	CJF396I18CR00R	CJF396B19CR00R
PICI 09F3 Guarnições 096 CA	RETO	CJF396E40CA00	CJF396E17CA002	CJF396I18CA00	CJF396B19CA00
	RED	CJF396E40CA00R	CJF396E17CA003	CJF396I18CA00R	CJF396B19CA00R
PICI 09F3 Guarnições 096 CT	RETO	CJF396E40CT00	CJF396E17CT002	CJF396I18CT00	CJF396B19CT00
	RED	CJF396E40CT00R	CJF396E17CT003	CJF396I18CT00R	CJF396B19CT00R

\* conjuntos sugeridos.

Para composições de conjuntos com as fechaduras 6000, 4900, 4800, 4910, 4700 e 1710, consulte nossa equipe.



MAÇANETAS E GUARNIÇÕES SEM FECHADURA	GUARNIÇÃO EXTERNA P/ CILINDRO 4000	GUARNIÇÃO EXTERNA P/ CILINDRO 3000	GUARNIÇÃO INTERNA	GUARNIÇÃO BANHEIRO
PICI 09F3 Guarnições 096 PP	SJF396P40PP00	SJF396P30PP00	SJF396P41PP00	SJF396P32PP00
PICI 09F3 Guarnições 096 CR	SJF396P40CR00	SJF396P30CR00	SJF396P41CR00	SJF396P32CR00
PICI 09F3 Guarnições 096 CA	SJF396P40CA00	SJF396P30CA00	SJF396P41CA00	SJF396P32CA00
PICI 09F3 Guarnições 096 CT	SJF396P40CT00	SJF396P30CT00	SJF396P41CT00	SJF396P32CT00

Foto do acabamento da guarnição em XP, somente para referência.

# PICI

## 09F3

Zamac

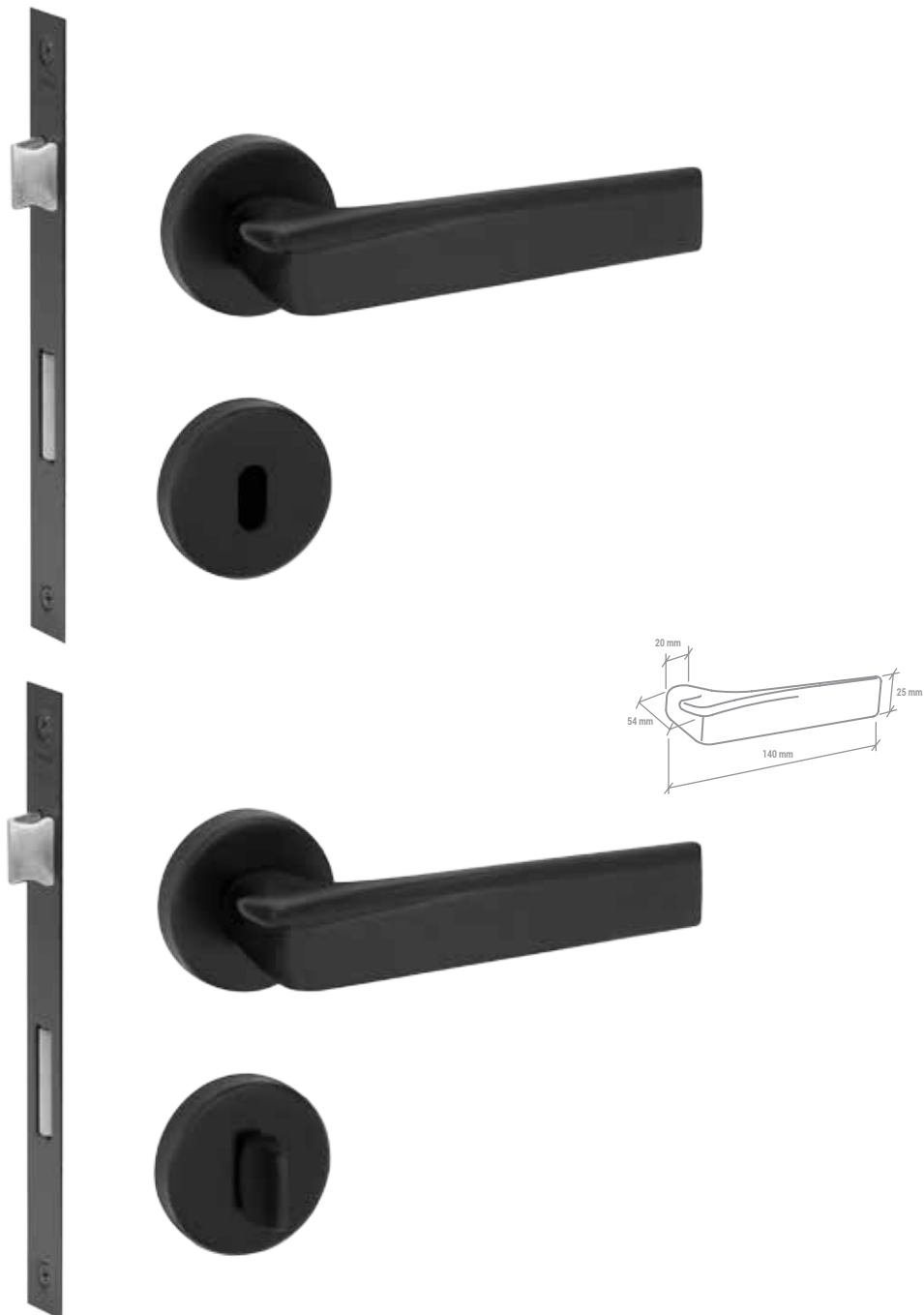

CONJUNTOS	CANTO	FECHADURA 4000 EXTERNA	FECHADURA 1700 EXTERNA (1750) CILINDRO 70MM	FECHADURA 1700 INTERNA (1851)	FECHADURA 1700 BANHEIRO (1952)
PICI 09F3 Guarnições 083 PP	RETO	CJF383E40PP00	CJF383E17PP002	CJF38318PP00	CJF383B19PP00
	RED	CJF383E40PP00R	CJF383E17PP003	CJF38318PP00R	CJF383B19PP00R
PICI 09F3 Guarnições 083 CR	RETO	CJF383E40CR00	CJF383E17CR002	CJF38318CR00	CJF383B19CR00
	RED	CJF383E40CR00R	CJF383E17CR003	CJF38318CR00R	CJF383B19CR00R
PICI 09F3 Guarnições 083 CA	RETO	CJF383E40CA00	CJF383E17CA002	CJF38318CA00	CJF383B19CA00
	RED	CJF383E40CA00R	CJF383E17CA003	CJF38318CA00R	CJF383B19CA00R
PICI 09F3 Guarnições 083 CT	RETO	CJF383E40CT00	CJF383E17CT002	CJF38318CT00	CJF383B19CT00
	RED	CJF383E40CT00R	CJF383E17CT003	CJF38318CT00R	CJF383B19CT00R

\* conjuntos sugeridos.

Para composições de conjuntos com as fechaduras 6000, 4900, 4800, 4910, 4700 e 1710, consulte nossa equipe.



MAÇANETAS E GUARNIÇÕES SEM FECHADURA	GUARNIÇÃO EXTERNA P/ CILINDRO 4000	GUARNIÇÃO EXTERNA P/ CILINDRO 3000	GUARNIÇÃO INTERNA	GUARNIÇÃO BANHEIRO
PICI 09F3 Guarnições 083 PP	SJF383P40PP00	SJF383P30PP00	SJF383P41PP00	SJF383P32PP00
PICI 09F3 Guarnições 083 CR	SJF383P40CR00	SJF383P30CR00	SJF383P41CR00	SJF383P32CR00
PICI 09F3 Guarnições 083 CA	SJF383P40CA00	SJF383P30CA00	SJF383P41CA00	SJF383P32CA00
PICI 09F3 Guarnições 083 CT	SJF383P40CT00	SJF383P30CT00	SJF383P41CT00	SJF383P32CT00

Foto do acabamento da guarnição em XP, somente para referência.



ALTZ  
09G7



ALT Z  
09 G 7



# ALTZ

## 09G7

Zamac

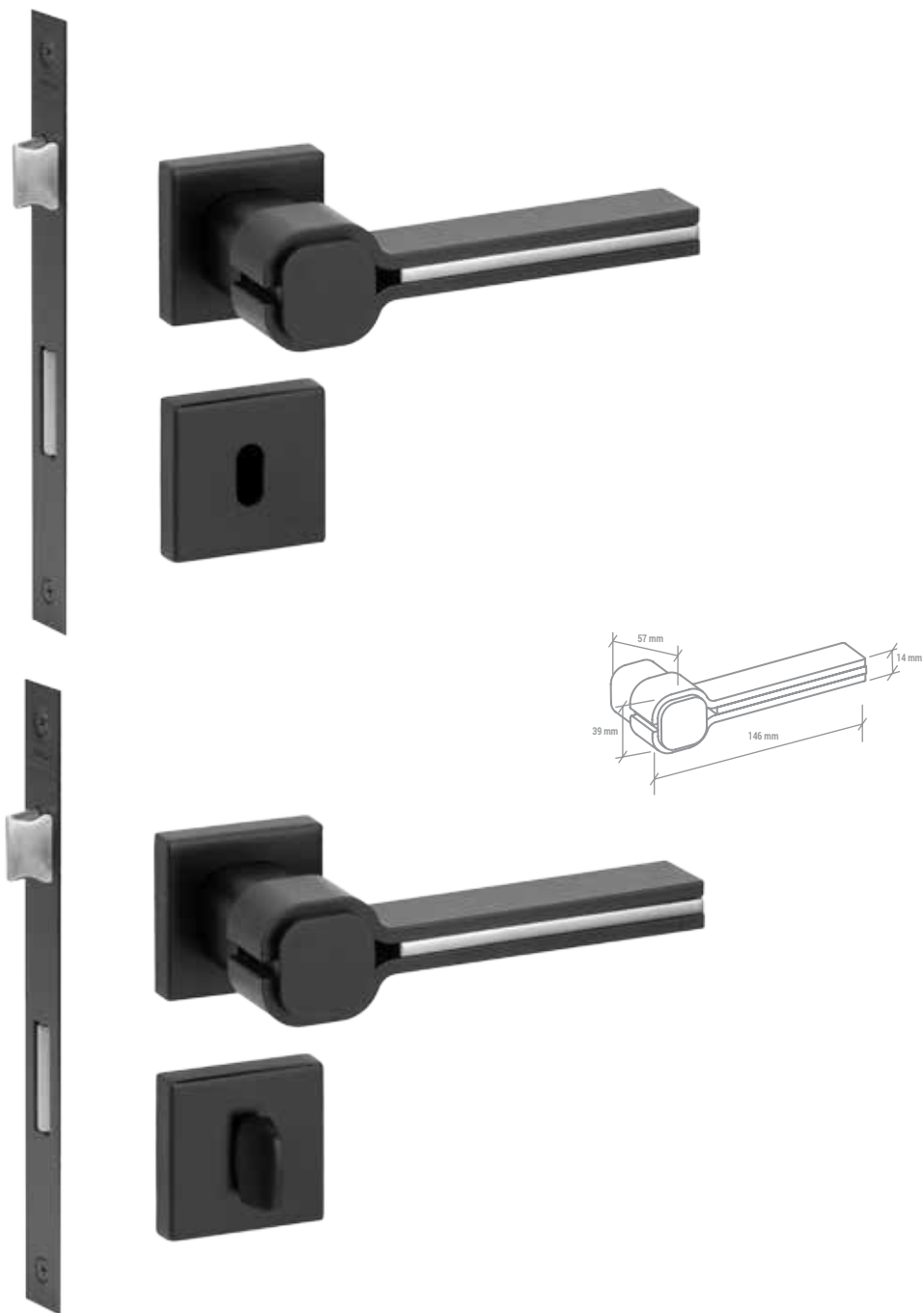

CONJUNTOS	CANTO	FECHADURA 4000 EXTERNA	FECHADURA 1700 EXTERNA (1750) CILINDRO 70MM	FECHADURA 1700 INTERNA (1851)	FECHADURA 1700 BANHEIRO (1952)
ALTZ 09G7 Guarnições 096 PP/XE	RETO	CJG796E40PPXE	CJG796E17PPXE2	CJG796I18PPXE	CJG796B19PPXE
	RED	CJG796E40PPXER	CJG796E17PPXE3	CJG796I18PPXER	CJG796B19PPXER
ALTZ 09G7 Guarnições 096 CT/PP	RETO	CJG796E40CTPP	CJG796E17CTPP2	CJG796I18CTPP	CJG796B19CTPP
	RED	CJG796E40CTPPR	CJG796E17CTPP3	CJG796I18CTPPR	CJG796B19CTPPR
ALTZ 09G7 Guarnições 096 CA/XP	RETO	CJG796E40CAXP	CJG796E17CAXP2	CJG796I18CAXP	CJG796B19CAXP
	RED	CJG796E40CAXPR	CJG796E17CAXP3	CJG796I18CAXPR	CJG796B19CAXPR
ALTZ 09G7 Guarnições 096 CR/XP	RETO	CJG796E40CRXP	CJG796E17CRXP2	CJG796I18CRXP	CJG796B19CRXP
	RED	CJG796E40CRXPR	CJG796E17CRXP3	CJG796I18CRXPR	CJG796B19CRXPR

\* conjuntos sugeridos.

Para composições de conjuntos com as fechaduras 6000, 4900, 4800, 4910, 4700 e 1710, consulte nossa equipe.



MAÇANETAS E GUARNIÇÕES SEM FECHADURA	GUARNIÇÃO EXTERNA P/ CILINDRO 4000	GUARNIÇÃO EXTERNA P/ CILINDRO 3000	GUARNIÇÃO INTERNA	GUARNIÇÃO BANHEIRO
ALTZ 09G7 Guarnições 096 PP/XE	SJG796P40PPXE	SJG796P30PPXE	SJG796P41PPXE	SJG796P32PPXE
ALTZ 09G7 Guarnições 096 CT/PP	SJG796P40CTPP	SJG796P30CTPP	SJG796P41CTPP	SJG796P32CTPP
ALTZ 09G7 Guarnições 096 CA/XP	SJG796P40CAXP	SJG796P30CAXP	SJG796P41CAXP	SJG796P32CAXP
ALTZ 09G7 Guarnições 096 CR/XP	SJG796P40CRXP	SJG796P30CRXP	SJG796P41CRXP	SJG796P32CRXP

Foto do acabamento da guarnição em XP, somente para referência.



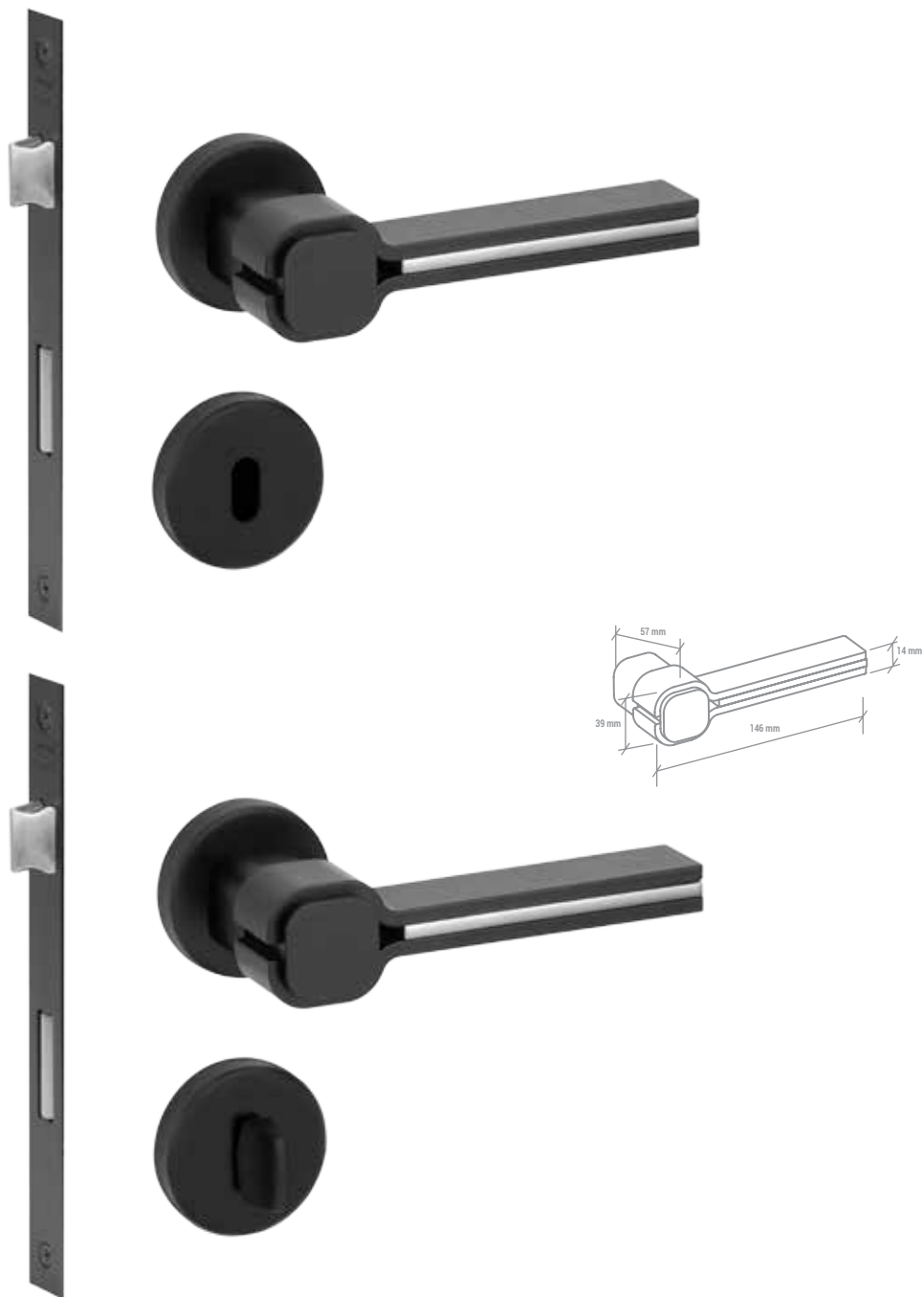

# ALTZ

09G7

Zamac



CONJUNTOS	CANTO	FECHADURA 4000 EXTERNA	FECHADURA 1700 EXTERNA (1750) CILINDRO 70MM	FECHADURA 1700 INTERNA (1851)	FECHADURA 1700 BANHEIRO (1952)
ALTZ 09G7 Guarnições 083 PP/XE	RETO	CJG783E40PPXE	CJG783E17PPXE2	CJG783I18PPXE	CJG783B19PPXE
	RED	CJG783E40PPXER	CJG783E17PPXE3	CJG783I18PPXER	CJG783B19PPXER
ALTZ 09G7 Guarnições 083 CT/PP	RETO	CJG783E40CTPP	CJG783E17CTPP2	CJG783I18CTPP	CJG783B19CTPP
	RED	CJG783E40CTPPR	CJG783E17CTPP3	CJG783I18CTPPR	CJG783B19CTPPR
ALTZ 09G7 Guarnições 083 CA/XP	RETO	CJG783E40CAXP	CJG783E17CAXP2	CJG783I18CAXP	CJG783B19CAXP
	RED	CJG783E40CAXPR	CJG783E17CAXP3	CJG783I18CAXPR	CJG783B19CAXPR
ALTZ 09G7 Guarnições 083 CR/XP	RETO	CJG783E40CRXP	CJG783E17CRXP2	CJG783I18CRXP	CJG783B19CRXP
	RED	CJG783E40CRXPR	CJG783E17CRXP3	CJG783I18CRXPR	CJG783B19CRXPR

\* conjuntos sugeridos.

Para composições de conjuntos com as fechaduras 6000, 4900, 4800, 4910, 4700 e 1710, consulte nossa equipe.



MAÇANETAS E GUARNIÇÕES SEM FECHADURA	GUARNIÇÃO EXTERNA P/ CILINDRO 4000	GUARNIÇÃO EXTERNA P/ CILINDRO 3000	GUARNIÇÃO INTERNA	GUARNIÇÃO BANHEIRO
ALTZ 09G7 Guarnições 083 PP/XE	SJG783P40PPXE	SJG783P30PPXE	SJG783P41PPXE	SJG783P32PPXE
ALTZ 09G7 Guarnições 083 CT/PP	SJG783P40CTPP	SJG783P30CTPP	SJG783P41CTPP	SJG783P32CTPP
ALTZ 09G7 Guarnições 083 CA/XP	SJG783P40CAXP	SJG783P30CAXP	SJG783P41CAXP	SJG783P32CAXP
ALTZ 09G7 Guarnições 083 CR/XP	SJG783P40CRXP	SJG783P30CRXP	SJG783P41CRXP	SJG783P32CRXP

Foto do acabamento da guarnição em XP, somente para referência.



LEMY  
09F7

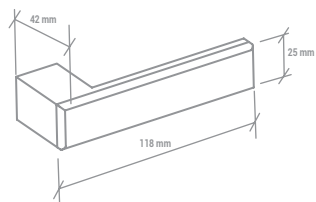

## LEMY

### 09F7

Inox



CONJUNTOS	CANTO	FECHADURA 4000 EXTERNA	FECHADURA 1700 EXTERNA (1750) CILINDRO 70MM	FECHADURA 1700 INTERNA (1851)	FECHADURA 1700 BANHEIRO (1952)
LEMY 09F7 Guarnições 096 XE/TA	RETO	CJF796E40XETA	CJF796E17XETA2	CJF796I18XETA	CJF796B19XETA
	RED	CJF796E40XETAR	CJF796E17XETA3	CJF796I18XETAR	CJF796B19XETAR
LEMY 09F7 Guarnições 096 XP/TA	RETO	CJF796E40XPETA	CJF796E17XPETA2	CJF796I18XPETA	CJF796B19XPETA
	RED	CJF796E40XPETAR	CJF796E17XPETA3	CJF796I18XPETAR	CJF796B19XPETAR

\* conjuntos sugeridos.  
Para composições de conjuntos com as fechaduras 6000, 4900, 4800, 4910, 4700 e 1710, consulte nossa equipe.

MOBILE  
0979

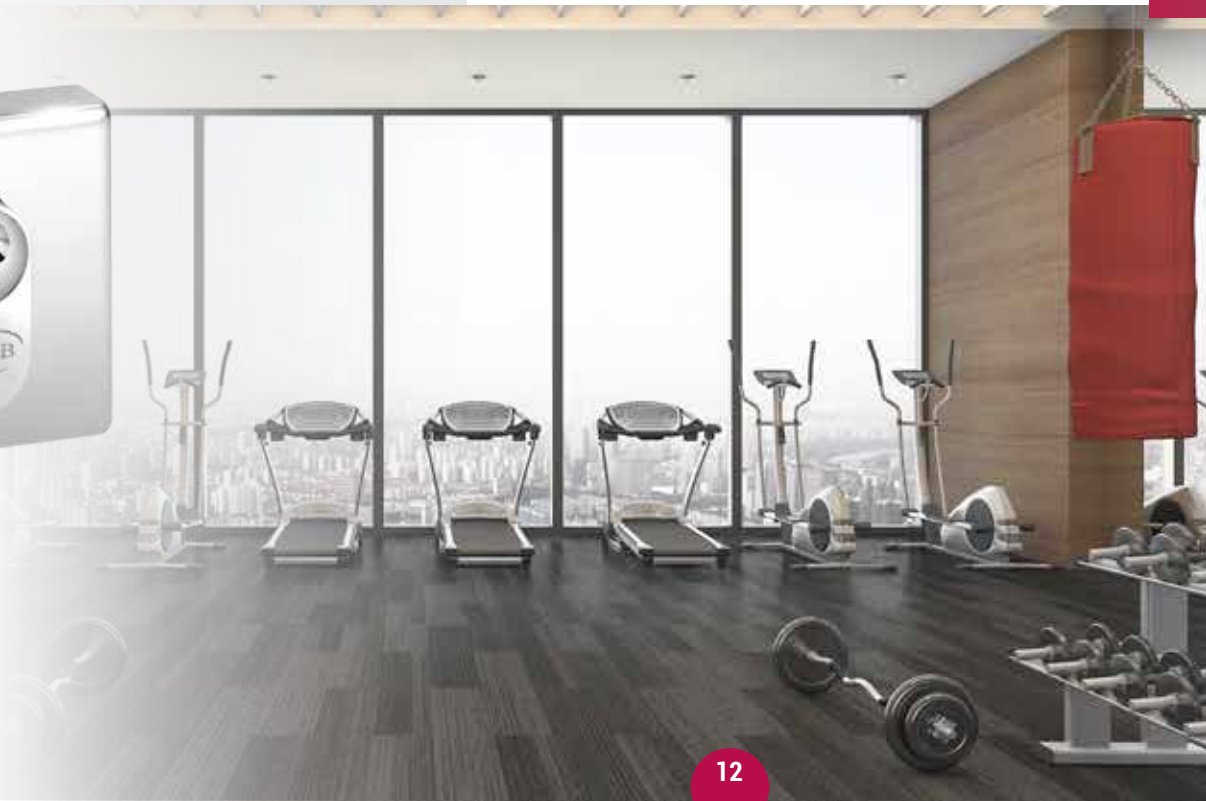

# MOBILE

0979

Latão

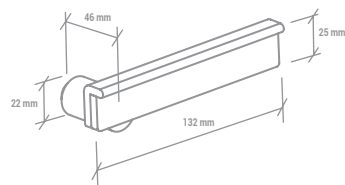

CONJUNTOS	CANTO	FECHADURA 4000 EXTERNA	FECHADURA 1700 EXTERNA (1750) CILINDRO 70MM	FECHADURA 1700 INTERNA (1851)	FECHADURA 1700 BANHEIRO (1952)
MOBILE 0979 Guarnições 096 CR/TA	RETO	CJ7996E40CRTA	CJ7996E17CRTA2	CJ7996I18CRTA	CJ7996B19CRTA
	RED	CJ7996E40CRTAR	CJ7996E17CRTA3	CJ7996I18CRTAR	CJ7996B19CRTAR
MOBILE 0979 Guarnições 096 CA/TA	RETO	CJ7996E40CATA	CJ7996E17CATA2	CJ7996I18CATA	CJ7996B19CATA
	RED	CJ7996E40CATAR	CJ7996E17CATA3	CJ7996I18CATAR	CJ7996B19CATAR

\* conjuntos sugeridos.

Para composições de conjuntos com as fechaduras 6000, 4900, 4800, 4910, 4700 e 1710, consulte nossa equipe.



LILY  
09B2

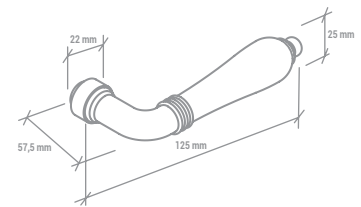
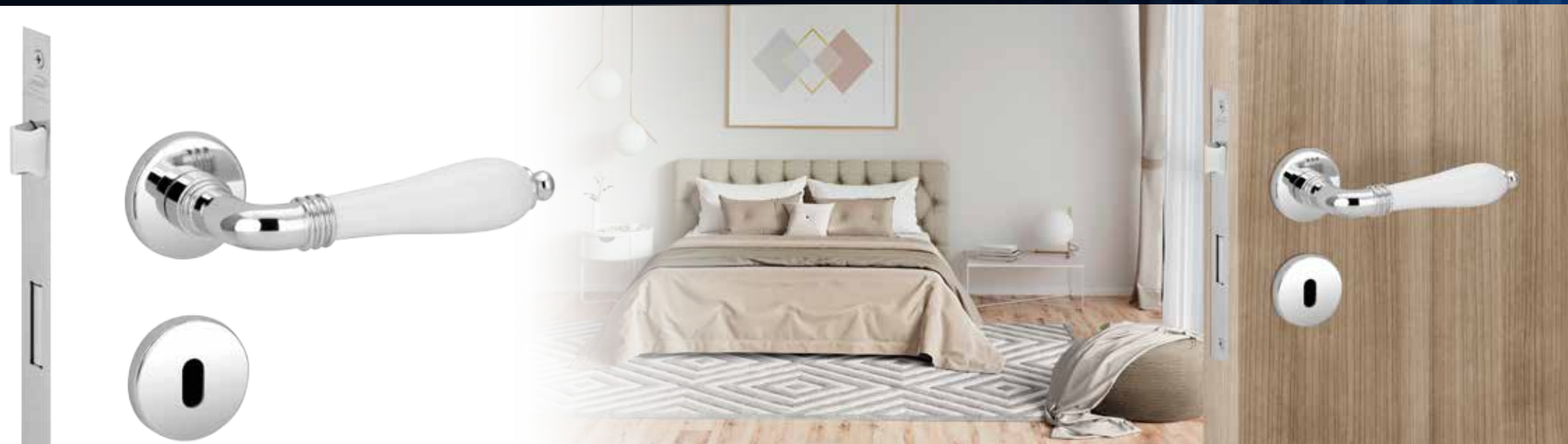

# LILY

## 09B2

Zamac



CONJUNTOS	CANTO	FECHADURA 1700 EXTERNA (1750) CILINDRO 70MM	FECHADURA 1700 INTERNA (1851)	FECHADURA 1700 BANHEIRO (1952)
LILY 09B2 Guarnições 066 CR/BC	RETO	CJB266E17CRBCK	CJB266I18CRBC	CJB266B19CRBC
	RED	CJB266E17CRBCJ	CJB266I18CRBCR	CJB266B19CRBCR
LILY 09B2 Guarnições 066 CR/PP	RETO	CJB266E17CRPPK	CJB266I18CRPP	CJB266B19CRPP
	RED	CJB266E17CRPPJ	CJB266I18CRPPR	CJB266B19CRPPR
LILY 09B2 Guarnições 066 CT/PP	RETO	CJB266E17CTPPK	CJB266I18CTPP	CJB266B19CTPP
	RED	CJB266E17CTPPJ	CJB266I18CTPPR	CJB266B19CTPPR
LILY 09B2 Guarnições 066 CT/BC	RETO	CJB266E17CTBCK	CJB266I18CTBC	CJB266B19CTBC
	RED	CJB266E17CTBCJ	CJB266I18CTBCR	CJB266B19CTBCR

\* conjuntos sugeridos.  
Para composições de conjuntos com as fechaduras 6000, 4900, 4800, 4910, 4700 e 1710, consulte nossa equipe.

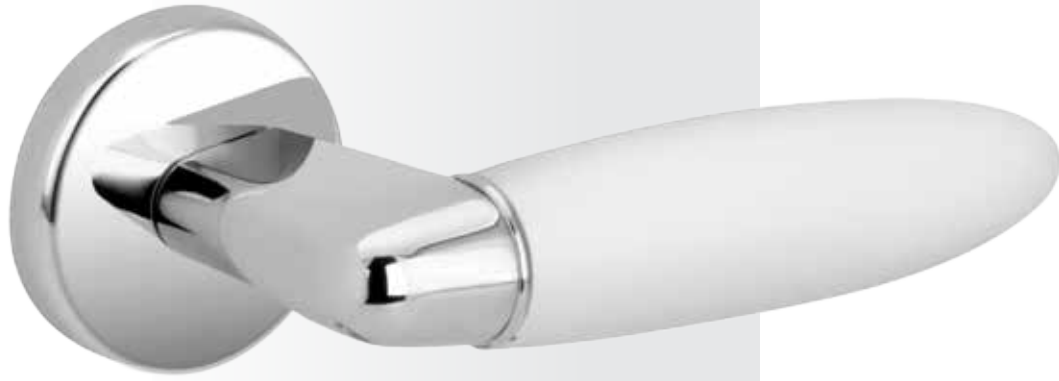

PETRA  
0924

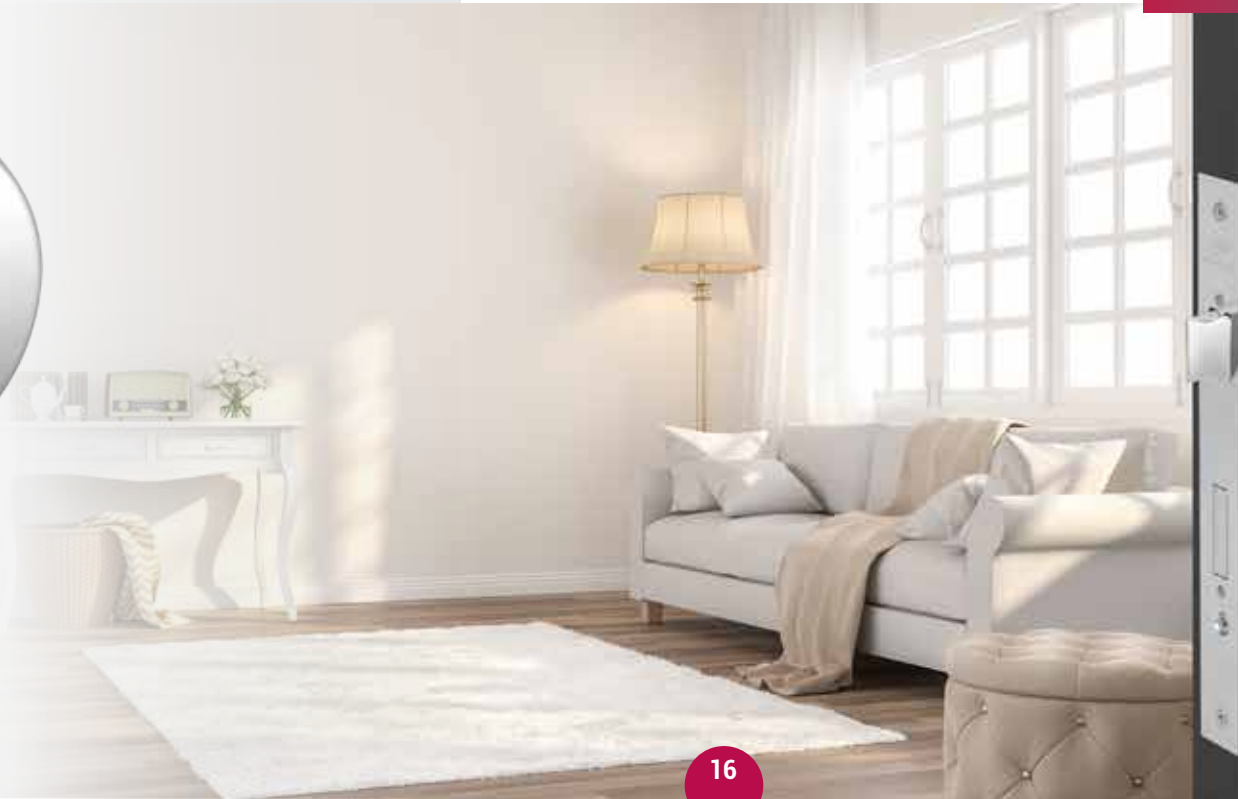



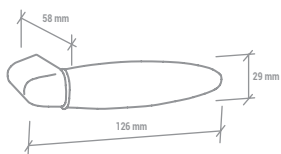

# PETRA

0924

Zamac



CONJUNTOS	CANTO	FECHADURA 4000 EXTERNA	FECHADURA 1700 EXTERNA (1750) CILINDRO 70MM	FECHADURA 1700 INTERNA (1851)	FECHADURA 1700 BANHEIRO (1952)
PETRA 0924 Guarnições 075 CR/BC	RETO	CJ2475E40CRBC	CJ2475E17CRBC2	CJ2475I18CRBC	CJ2475B19CRBC
	RED	CJ2475E40CRBCR	CJ2475E17CRBC3	CJ2475I18CRBCR	CJ2475B19CRBCR
PETRA 0924 Guarnições 075 CA/BC	RETO	CJ2475E40CABC	CJ2475E17CABC2	CJ2475I18CABC	CJ2475B19CABC
	RED	CJ2475E40CABCR	CJ2475E17CABC3	CJ2475I18CABCR	CJ2475B19CABCR
PETRA 0924 Guarnições 075 CR/PP	RETO	CJ2475E40CRPP	CJ2475E17CRPP2	CJ2475I18CRPP	CJ2475B19CRPP
	RED	CJ2475E40CRPPR	CJ2475E17CRPP3	CJ2475I18CRPPR	CJ2475B19CRPPR
PETRA 0924 Guarnições 075 CA/PP	RETO	CJ2475E40CAPP	CJ2475E17CAPP2	CJ2475I18CAPP	CJ2475B19CAPP
	RED	CJ2475E40CAPPR	CJ2475E17CAPP3	CJ2475I18CAPPR	CJ2475B19CAPPR

\* conjuntos sugeridos.

Para composições de conjuntos com as fechaduras 6000, 4900, 4800, 4910, 4700 e 1710, consulte nossa equipe.



MAÇANETAS E GUARNIÇÕES SEM FECHADURA	GUARNIÇÃO EXTERNA P/ CILINDRO 4000	GUARNIÇÃO EXTERNA P/ CILINDRO 3000	GUARNIÇÃO INTERNA	GUARNIÇÃO BANHEIRO
PETRA 0924 Guarnições 075 CR/BC	SJ2475P40CRBC	SJ2475P30CRBC	SJ2475P41CRBC	SJ2475P32CRBC
PETRA 924 Guarnições 075 CA/BC	SJ2475P40CABC	SJ2475P30CABC	SJ2475P41CABC	SJ2475P32CABC
PETRA 924 Guarnições 075 CR/PP	SJ2475P40CRPP	SJ2475P30CRPP	SJ2475P41CRPP	SJ2475P32CRPP
PETRA 924 Guarnições 075 CA/PP	SJ2475P40CAPP	SJ2475P30CAPP	SJ2475P41CAPP	SJ2475P32CAPP

Foto do acabamento da guarnição em CR, somente para referência.



D U E R O  
0 9 B 3

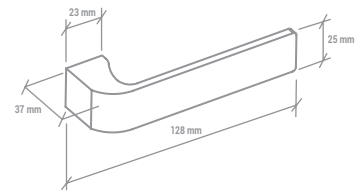

# DUERO

## 09B3

Zamac



CONJUNTOS	CANTO	FECHADURA 1700 EXTERNA (1750) CILINDRO 70MM	FECHADURA 1700 INTERNA (1851)	FECHADURA 1700 BANHEIRO (1952)
DUERO 09B3 Guarnições 096 AQ	RETO	CJB396E17AQ002	CJB396I18AQ00	CJB396B19AQ00
	RED	CJB396E17AQ003	CJB396I18AQ00R	CJB396B19AQ00R
DUERO 09B3 Guarnições 096 CA	RETO	CJB396E17CA002	CJB396I18CA00	CJB396B19CA00
	RED	CJB396E17CA003	CJB396I18CA00R	CJB396B19CA00R

\* conjuntos sugeridos.  
Para composições de conjuntos com as fechaduras 6000, 4900, 4800, 4910, 4700 e 1710, consulte nossa equipe.

TESCA 2  
09E3

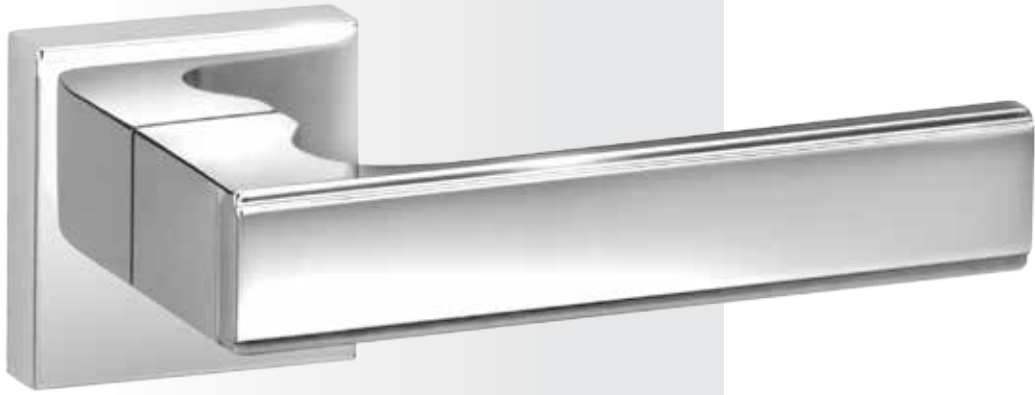



## TESCA 2

### 09E3

Zamac

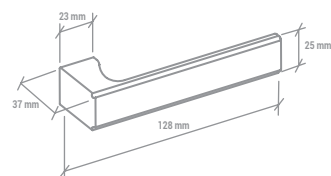

CONJUNTOS	CANTO	FECHADURA 1700 EXTERNA (1750) CILINDRO 70MM	FECHADURA 1700 INTERNA (1851)	FECHADURA 1700 BANHEIRO (1952)
TESCA2 09E3 Guarnições 096 CR	RETO	CJE396E17CR002	CJE396I18CR00	CJE396B19CR00
	RED	CJE396E17CR003	CJE396I18CR00R	CJE396B19CR00R
TESCA2 09E3 Guarnições 096 CA	RETO	CJE396E17CA002	CJE396I18CA00	CJE396B19CA00
	RED	CJE396E17CA003	CJE396I18CA00R	CJE396B19CA00R
TESCA2 09E3 Guarnições 096 AQ	RETO	CJE396E17AQ002	CJE396I18AQ00	CJE396B19AQ00
	RED	CJE396E17AQ003	CJE396I18AQ00R	CJE396B19AQ00R
TESCA2 09E3 Guarnições 096 BC	RETO	CJE396E17BC002	CJE396I18BC00	CJE396B19BC00
	RED	CJE396E17BC003	CJE396I18BC00R	CJE396B19BC00R
TESCA2 09E3 Guarnições 096 PP	RETO	CJE396E17PP002	CJE396I18PP00	CJE396B19PP00
	RED	CJE396E17PP003	CJE396I18PP00R	CJE396B19PP00R

\* conjuntos sugeridos.  
Para composições de conjuntos com as fechaduras 6000, 4900, 4800, 4910, 4700 e 1710, consulte nossa equipe.



METRO STRIP  
09G8

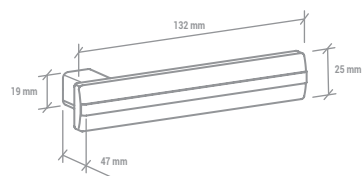

## METRO STRIP

09G8  
Latão



CONJUNTOS	CANTO	FECHADURA 4000 EXTERNA	FECHADURA 1700 EXTERNA (1750) CILINDRO 70MM	FECHADURA 1700 INTERNA (1851)	FECHADURA 1700 BANHEIRO (1952)
METRO STRIP 09G8 Guarnições 096 CR/MR	RETO	CJG896E40CRM	CJG896E17CRM2	CJG896I18CRM	CJG896B19CRM
	RED	CJG896E40CRMRR	CJG896E17CRM3	CJG896I18CRMRR	CJG896B19CRMRR
METRO STRIP 09G8 Guarnições 096 CA/CR	RETO	CJG896E40CACR	CJG896E17CACR2	CJG896I18CACR	CJG896B19CACR
	RED	CJG896E40CACRR	CJG896E17CACR3	CJG896I18CACRR	CJG896B19CACRR
METRO STRIP 09G8 Guarnições 096 PP/CR	RETO	CJG896E40PPCR	CJG896E17PPCR2	CJG896I18PPCR	CJG896B19PPCR
	RED	CJG896E40PPCRR	CJG896E17PPCR3	CJG896I18PPCRR	CJG896B19PPCRR

\* conjuntos sugeridos.  
Para composições de conjuntos com as fechaduras 6000, 4900, 4800, 4910, 4700 e 1710, consulte nossa equipe.

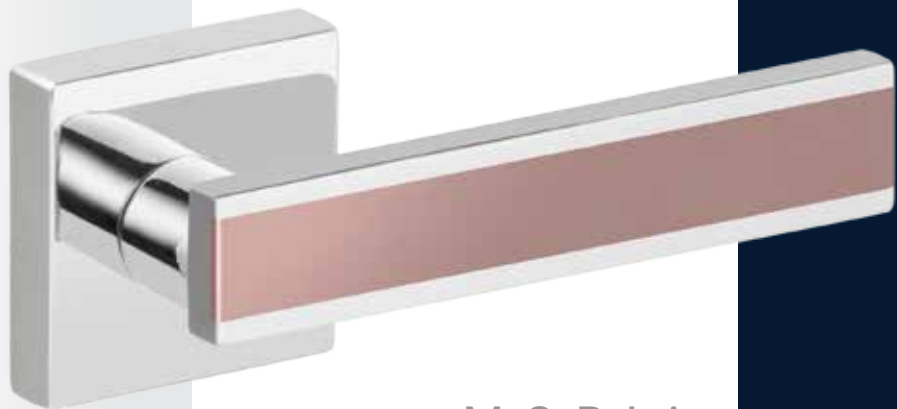

MOBIA  
STRIP  
09G5



METRODIA  
TOP  
09G9





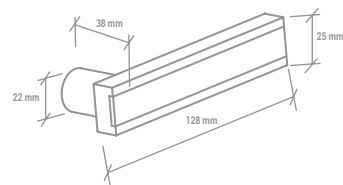

# MOBIA STRIP

09G5

Latão



CONJUNTOS	CANTO	FECHADURA 4000 EXTERNA	FECHADURA 1700 EXTERNA (1750) CILINDRO 70MM	FECHADURA 1700 INTERNA (1851)	FECHADURA 1700 BANHEIRO (1952)
MOBIA STRIP 09G5 Guarnições 096 CR/MR	RETO	CJG596E40CRM	CJG596E17CRM2	CJG596I18CRM	CJG596B19CRM
	RED	CJG596E40CRMRR	CJG596E17CRM3	CJG596I18CRMRR	CJG596B19CRMRR
MOBIA STRIP 09G5 Guarnições 096 CA/CR	RETO	CJG596E40CACR	CJG596E17CACR2	CJG596I18CACR	CJG596B19CACR
	RED	CJG596E40CACRR	CJG596E17CACR3	CJG596I18CACRR	CJG596B19CACRR
MOBIA STRIP 09G5 Guarnições 096 PP/CR	RETO	CJG596E40PPCR	CJG596E17PPCR2	CJG596I18PPCR	CJG596B19PPCR
	RED	CJG596E40PPCRR	CJG596E17PPCR3	CJG596I18PPCRR	CJG596B19PPCRR

\* conjuntos sugeridos.

Para composições de conjuntos com as fechaduras 6000, 4900, 4800, 4910, 4700 e 1710, consulte nossa equipe.



# METRODIA TOP

09G9

Latão



CONJUNTOS	CANTO	FECHADURA 4000 EXTERNA	FECHADURA 1700 EXTERNA (1750) CILINDRO 70MM	FECHADURA 1700 INTERNA (1851)	FECHADURA 1700 BANHEIRO (1952)
METRODIA TOP 09G9 Guarnições 096 CR/MR	RETO	CJG996E40CRMRR	CJG996E17CRM2	CJG996I18CRM	CJG996B19CRM
	RED	CJG996E40CRMRR	CJG996E17CRM3	CJG996I18CRMRR	CJG996B19CRMRR
METRODIA TOP 09G9 Guarnições 096 CA/CR	RETO	CJG996E40CACR	CJG996E17CACR2	CJG996I18CACR	CJG996B19CACR
	RED	CJG996E40CACRR	CJG996E17CACR3	CJG996I18CACRR	CJG996B19CACRR
METRODIA TOP 09G9 Guarnições 096 PP/CR	RETO	CJG996E40PPCR	CJG996E17PPCR2	CJG996I18PPCR	CJG996B19PPCR
	RED	CJG996E40PPCRR	CJG996E17PPCR3	CJG996I18PPCRR	CJG996B19PPCRR

\* conjuntos sugeridos.

Para composições de conjuntos com as fechaduras 6000, 4900, 4800, 4910, 4700 e 1710, consulte nossa equipe.

## LANÇAMENTOS IMAB 2021

As fechaduras e ferragens **IMAB** destacam-se pela qualidade, segurança e designs exclusivos. Tecnologia e acabamentos primorosos elevam o padrão mantendo a Excelência em cada ambiente. Os produtos são avaliados pelo rigoroso controle de qualidade **IMAB**, excedendo as normativas impostas pela ABNT/NBR 14913. Garantia de 10 anos contra defeitos de fabricação no funcionamento.















Os lançamentos apresentados estão com sugestões de conjuntos de fechadura, maçanetas e guarnições. Confira os produtos com a diversidade de fechaduras e guarnições em opções de rosetas quadradas, redondas ou espelhos. Para chapa testa e contratesta, opções de cantos quadrados ou redondos. Além da magnífica cartela de acabamentos. Uma infinidade de composições.



EXCELÊNCIA EM CADA AMBIENTE



## A C A B A M E N T O S

-  OA - Amarelo Polido
-  AA - Amarelo Acetinado
-  AQ - Antique
-  AP - Anodizado Preto
-  BC - Branco
-  CA - Cromo Acetinado
-  CR - Cromado
-  CT - Corten
-  MR - Marrom
-  OU - Ouro
-  PC - Pintado Cromado
-  PP - Preto Pintado
-  XP - Inox Polido
-  XE - Inox Escovado
-  OS - Fumê

\* as imagens das cores são referências, podendo haver variação de textura e tonalidade.



📍 Estrada Mina de Ouro, 280 - Itararé  
Embu-Guaçu/SP - Brasil - CEP 06900-000

☎ (11) 4662-7500 | FAX: (11) 4661-2149

✉ imab@imab.com.br

🌐 www.imab.com.br   imabfechaduras

